

# BALUSTRADE - BA-309

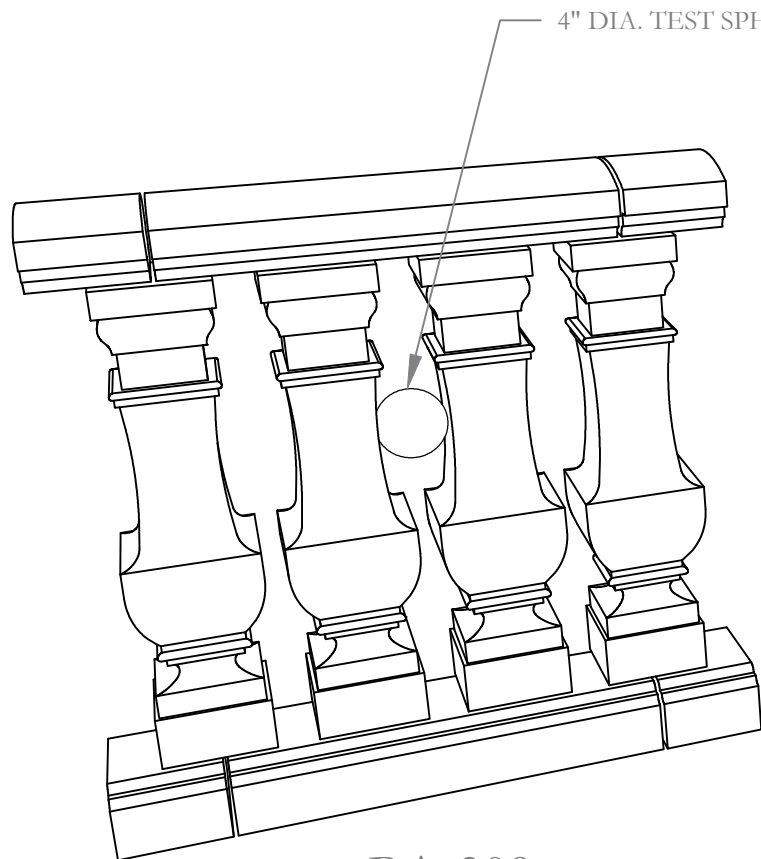

BA-309  
Balustrade  
8 1/4" O.C. per Code

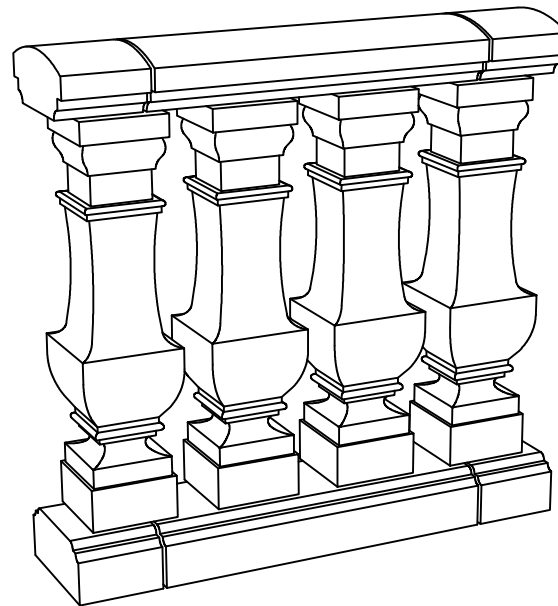

BA-309  
Balustrade  
9" O.C.

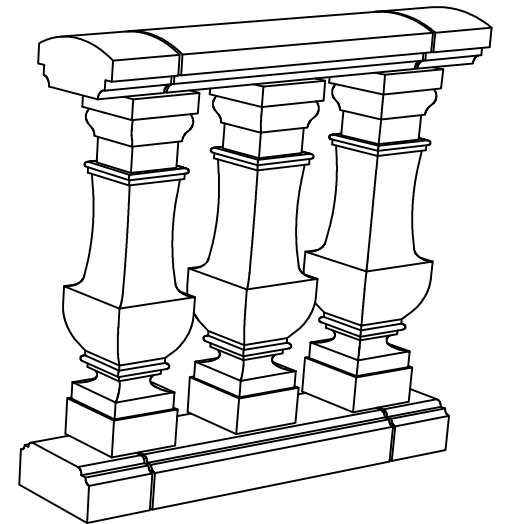

BA-309  
Balustrade  
12" O.C.

Notes:

1. All Base Rails and Handrails shall be provided in 24" lengths, typical.
2. Code O.C. (Baluster On Center) spacing is required when balustrade is used as a guardrail where there is a grade change of 30" or greater.
3. Guardrails must be 42" high per code. Balustrade requires a 6" high base by others in order to make the handrail 42" off of grade.



architectural stone and tile

[www.mstoneandtile.com](http://www.mstoneandtile.com)

BA-309  
BALUSTRADE

New Balustrade